





36 607 985

- Roseta 60 x 60 mm
- Montura con husillo ajustable y camisa



	Platino	36 607 985-08
	Cromo	36 607 985-00
	Platino cepillado	36 607 985-06
	Latón cepillado (Oro 23k)	36 607 985-28
	Cromo cepillado	36 607 985-93
	Dark Platinum cepillado	36 607 985-99

Complementos necesarios



- Válvula empotrada 1/2" -** 35 607 970 90
- Profundidad de montaje mín. 75 mm
 - Profundidad de montaje máx. 145 mm

36 607 985

mm [inches]

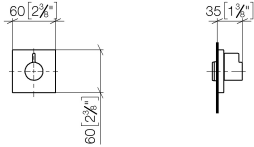

Certificado

DVGW_DW-
6501DN0116.

WRAS_2011026.

IAPMO_4976 (2).

LGA_29931.

WRAS_2010066.

DVGW_DW-
6512DN0706.

LGA_29932.

36 607 985

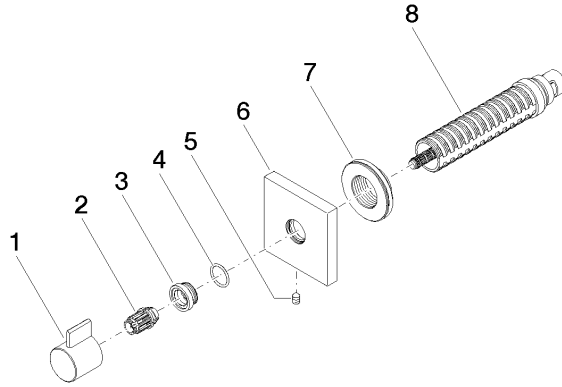

Lista de piezas de recambios

N°	Número de artículo	Denominación	Cantidad de montaje	Plazo de entrega
1	09 20 98 002-08	manilla	1	40
2	09 12 12 005 90	manguito de engaste	1	2
3	09 12 12 043-08	alojamiento	1	40
4	09 14 10 017 90	sello	1	2
5	90 31 11 004 00 90	varilla	1	2
6	09 27 98 014-08	roseta	1	40
7	09 21 02 151 90	camisa	1	2
8	90 90 03 202 00 90	parte superior	1	2